

# FOUR-NODE MOTIF DICTIONARY

ID labels match the output from mfinder1.1 motif-finding software provided by Uri Alon.

---

## Stability Class I: feed-forward

### 3 links

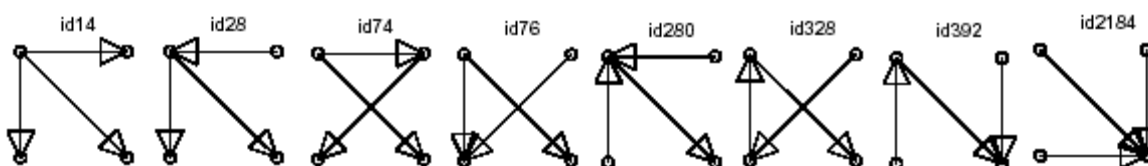

### 4 links

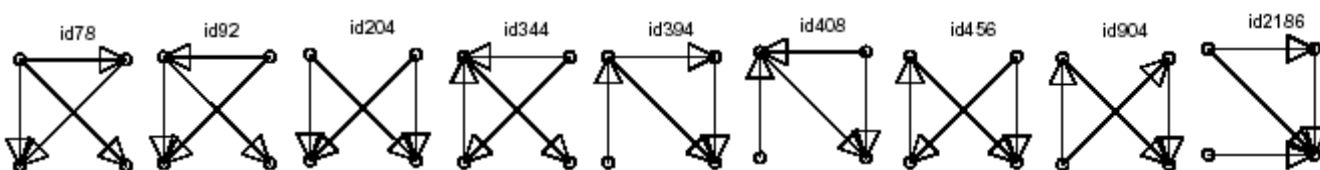

### 5 links

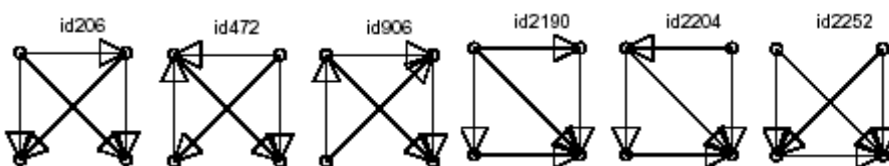

### 6 links

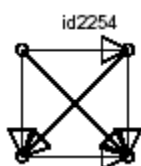

## Stability Class II: one 2-node loop

### 4 links

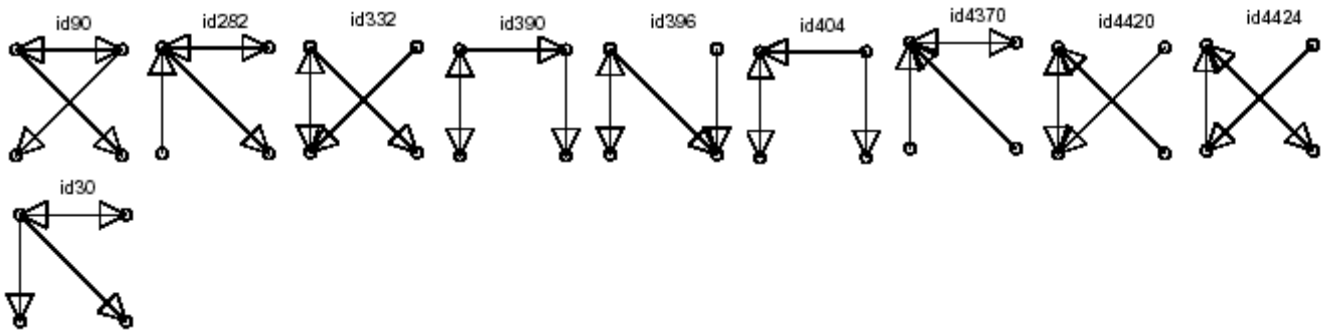

**5 links**

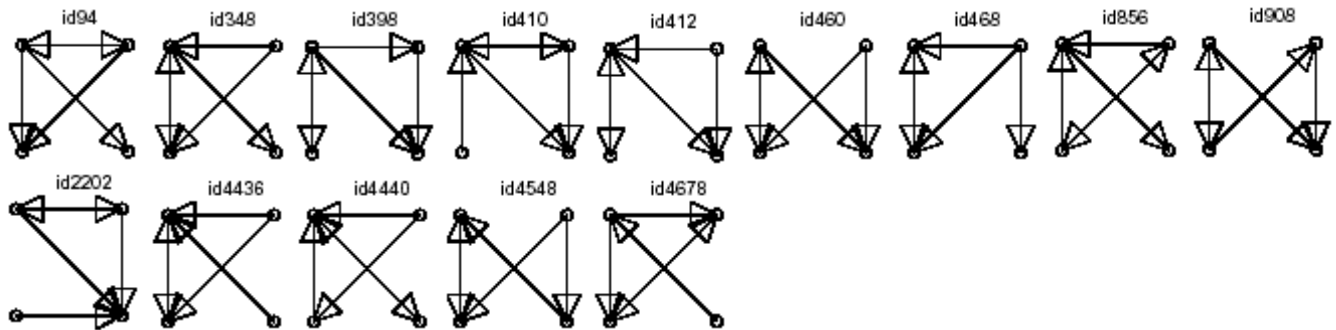

**6 links**

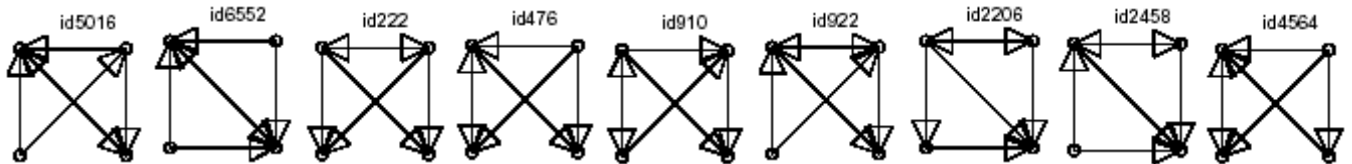

**7 links**

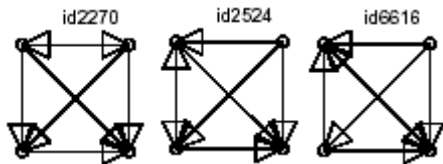

**Stability Class III: more complicated loops**

**4 links**

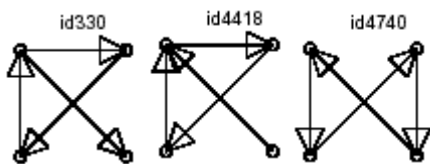

## 5 links

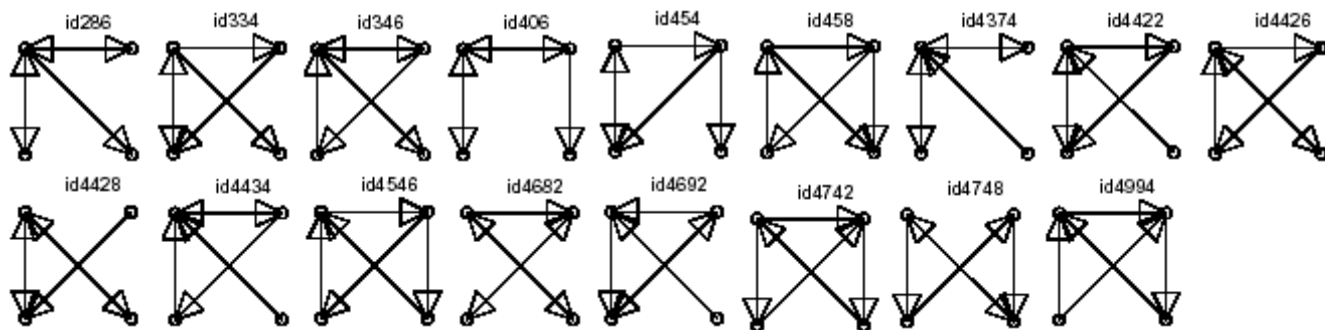

## 6 links

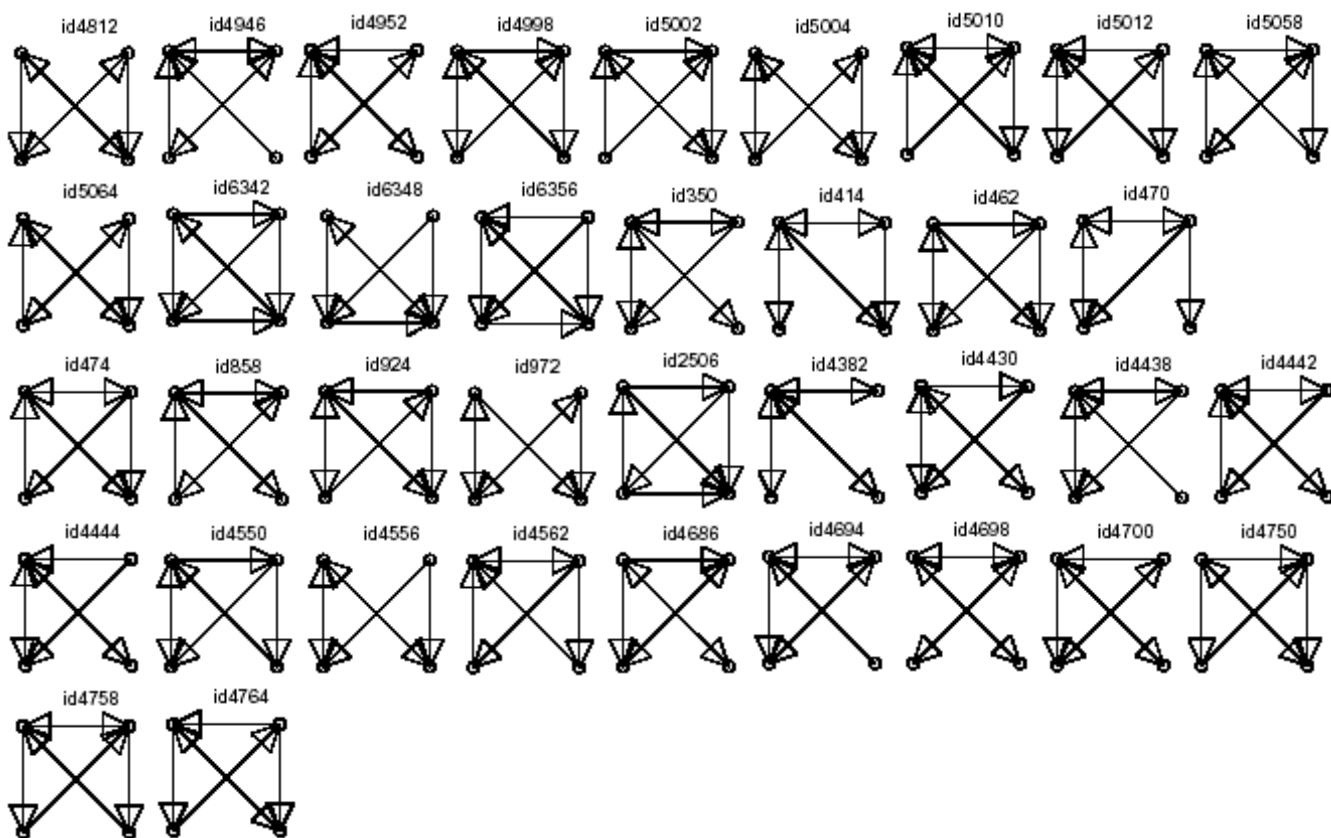

## 7 links

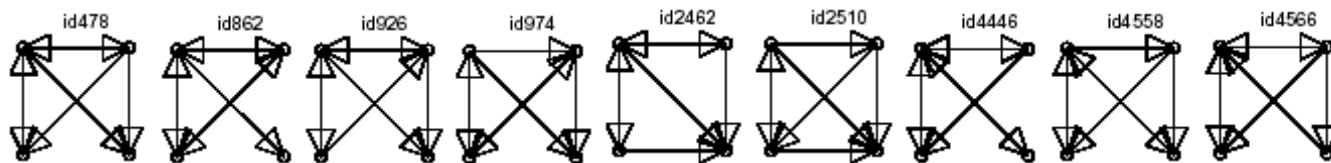

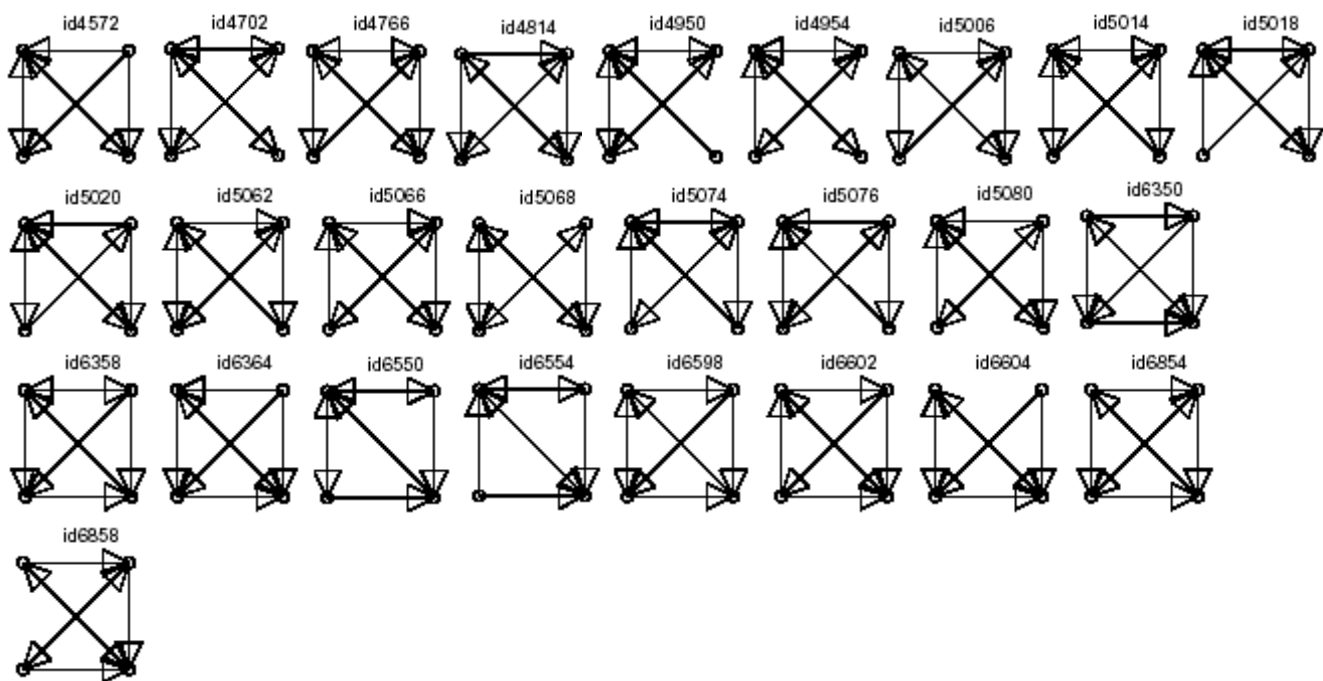

### 8 links

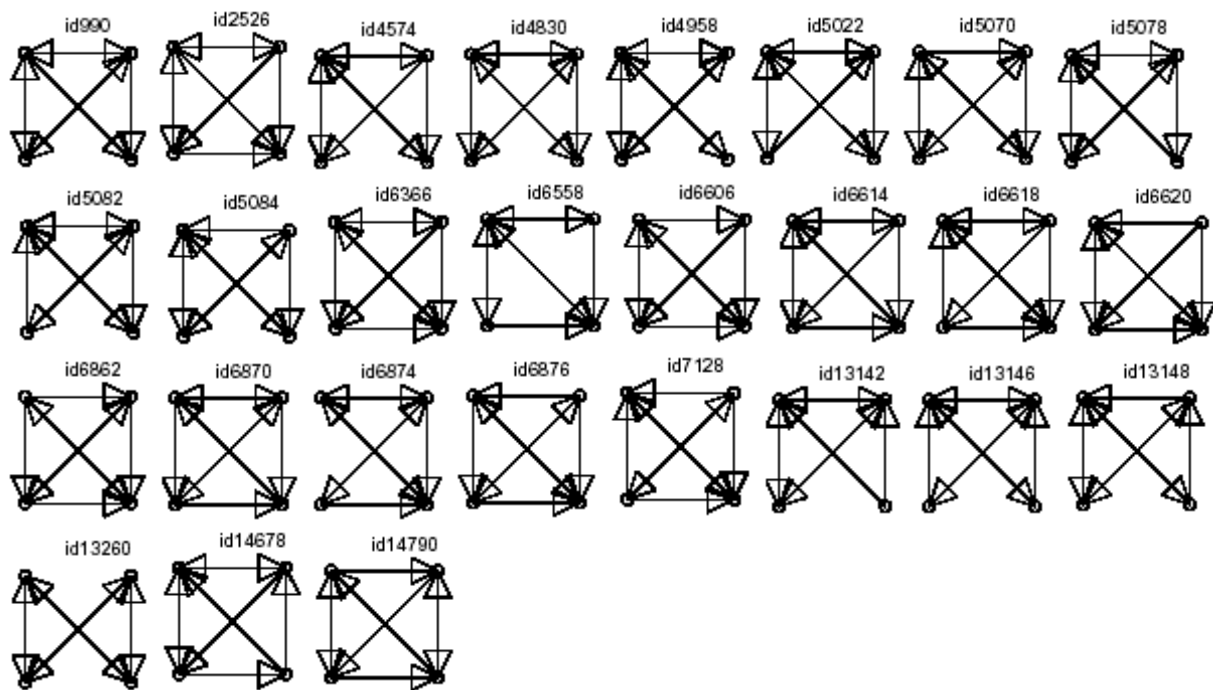

### 9 links

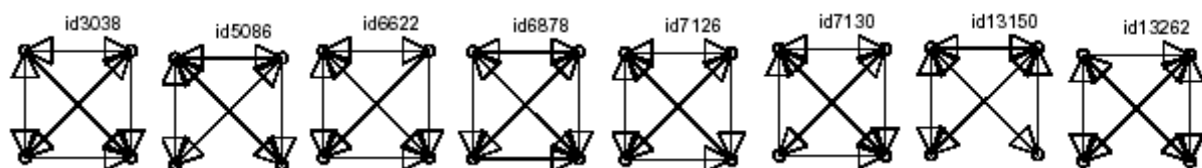

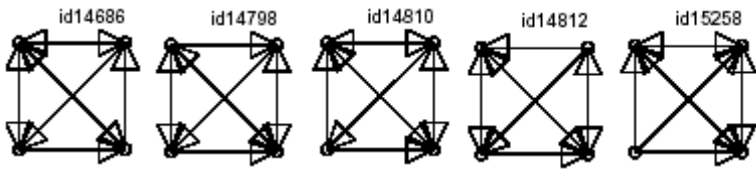

**10 links**

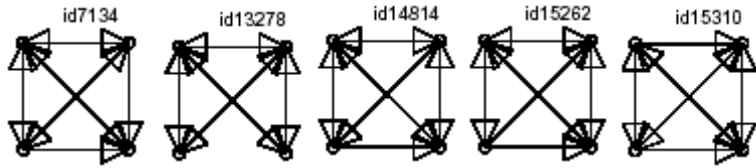

**11 links**

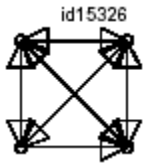

**12 links**

